

SOLUS 9

The Solus 9 is a high-intensity LED Task Light with light intensity comparable to that of a conventional 50W halogen light source. The energy consumption is significantly lower saving approximately 85% compared to halogen.

Standard features include dimmer functionality and IP65 rating on low voltage models making the product suitable for a wide variety of applications. The Sunnex flexible gooseneck provides vibration-resistant positioning and the LED light source emits virtually no heat.

Custom versions available.

Features

- Up to 36000Lux light output at 500mm
- Low energy consumption
- Colour Rendering Index (CRI) of 92 making the light suitable for colour-critical applications
- IP20, IP65
- Dimmer switch in the durable aluminium lamp head

Applications

- Targeted at industry customers who needs task light with focused light intensity
- For customers with specific need of dimming in the high intensity segment

Benefits

- Flexible gooseneck arm for easy positioning
- Articulated arm system for long reach
- Rugged design
- High quality





Technical specifications

Supply voltage	12-24V AC/DC, 1,9m cordset (100-240VAC) Plugin AC/DC-adaptor available, IP44
Power consumption	6W
Arm Length	500, 700, 1000, 1250mm or Spot
Colour	Black
Colour temperature	4000K
IP rating	IP20 or IP65
Protection Class	III
Beam angle	10° std. 25° and 40° as accessory
Light output	390Lm, 39500Lx at 500mm (10°)
Colour rendering index	92
Weight	1,6-2,5kg
Technical lifespan	>50000h
Dimmer	Standard

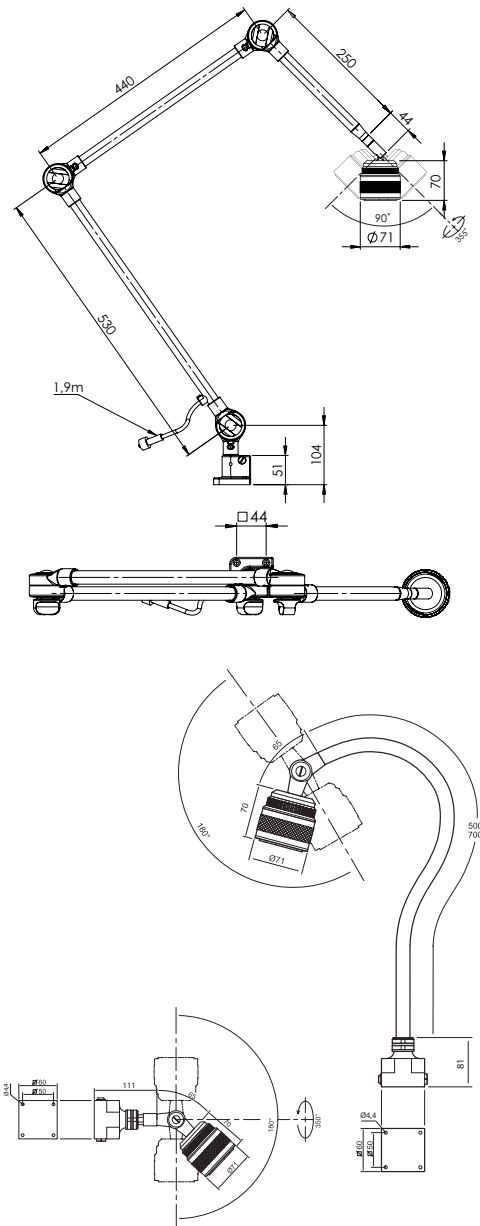
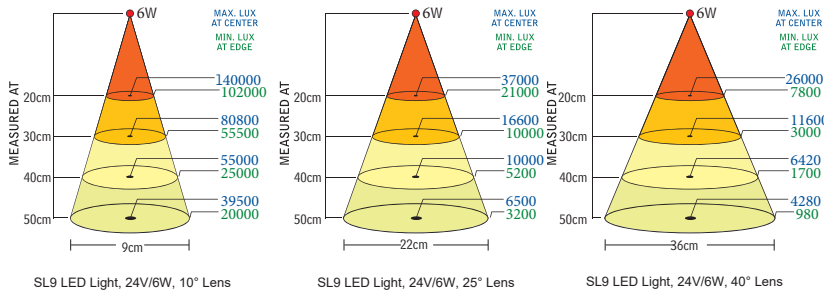

Arm	Connection	Optics	Version	Part no.
500mm	12-24V AC/DC	10°	IP65	33310
500mm	12-24V AC/DC	25°	IP65	33310-25
700mm	12-24V AC/DC	10°	IP65	33330
700mm	12-24V AC/DC	25°	IP65	33330-25
1000mm AAS	12-24V AC/DC	10°	IP20	33355
1000mm AAS	12-24V AC/DC	25°	IP20	33355-25
1250mm AAS	12-24V AC/DC	10°	IP20	33353
1250mm AAS	12-24V AC/DC	25°	IP20	33353-25
Spot	12-24V AC/DC	10°	IP20	33360
Spot	12-24V AC/DC	25°	IP20	33360-25

PSU (100-240V~)

Plug-in Adaptor for Europe 230V
33901

Mounting Accessories

Magnetic base
12010

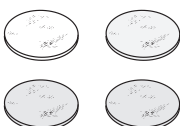

Table base
14015

C-Clamp
14020

Wall mount
14030

ACCESSORIES & SPAREPARTS

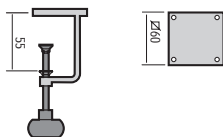
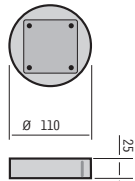
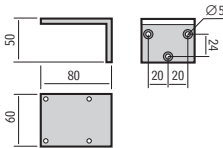
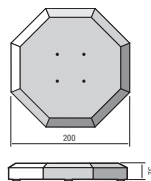
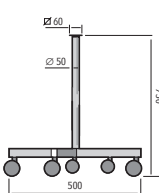
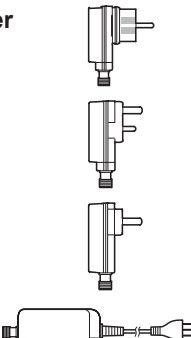

Accessory	Suitable for	Info	Part. no.
Lins/Glas 	Solus 9 / Solus 6	Clear (std)	18004
	Solus 9 / Solus 6	Frosted	18005
Optics 	Solus 9 / Solus 6	10°	33910
	Solus 9 / Solus 6	25°	33925
	Solus 9 / Solus 6	40°	33940
C-clamp 	All with std. base M4 x 20 (4x) included	Max. 42mm	14020
Magnetic base 	Solus 9/Luxor/Solus 6 M4 x 20 (4x) included	Ø 110mm	12010
Wallmount 	All with std. base M4 x 20 (4x) included	50 x 80mm	14030
Desktop base 	All with std. base 4,0 x 25 (4x) included	Ø 200mm	14015
Trolley base 	All with std. base M4 x 20 (4x) included	Height 750mm	14024
AC/DC-Adapter 	Pluto/Tellus/Solus6/Solus9/Lumius/LS CL-LED/Luxor (Euro)	100-240V/24VDC Max 15VA, IP44	33901
	Pluto/Tellus/Solus6/Solus9/Lumius/LS (UK)	100-240V/12VDC Max 12VA, IP44	33902
	Pluto/Tellus/Solus6/Solus9/Lumius/LS (US)	100-240V/12VDC Max 12VA, IP44	33906
	Pluto/Tellus/Solus6/Solus9/Lumius/LS CL-LED/Luxor (CH)	100-240V/24VDC Max 15VA, IP44	33907