

# TELLUS R/W

Tellus R/W is a task light designed specifically for vehicle and applications where night vision is of great importance. Such applications can be a ship bridge or a train cab.

The lamp head is made from durable aluminium and the sturdy flexible arm allows for accurate adjustment of the lamp head position yet maintaining good vibration resistance.

The light colour can easily be switched between white and red light, the built-in dimming function allows for precise adjustment of the light intensity, down to approximately 2% intensity. Tellus R/W has an extended shade for protection against glare and provides a focused light pattern. Supply voltage is SELV 12-24V for direct connection in vehicles and similar applications, adaptor for connection to the power net is available as an accessory.

Suitable applications are ships, trains and other vehicles.

Our accessories like C-clamp, wall bracket, magnetic base and table base can be used with this product.

Customized versions are available.

## Features

- Flexible arm
- LED service life >30000h
- 12-24V AC/DC supply voltage
- Red and white light colour
- Dimmable

## Applications

- Ship bridges
- Train cabs
- Road going vehicles

## Benefits

- Low power consumption
- Very low heat emission
- Switchable between red and white light colour
- Flexible arm for accurate adjustment





### Technical specifications

Supply voltage	12-24V AC/DC, 1,9m cord set (100-240VAC Plugin AC/DC-adaptor available, IP44)
Power consumption	5W
Arm length	500 or 700mm
Colour	Black
Colour temperature	6500K, Red 630nm
IP-rating	IP20 or IP43
Protection Class	III
Beam angle	45°
Light output	77Lm, White 600Lx at 500mm distance, Red 150Lx at 500mm distance
Colour rendering index	80 (6500K)
EMC	EN 55015: 2019 + A11:2020, EN 60533:2015 (Bridge)
Weight	1,5-1,7kg
Technical lifespan	>30000h

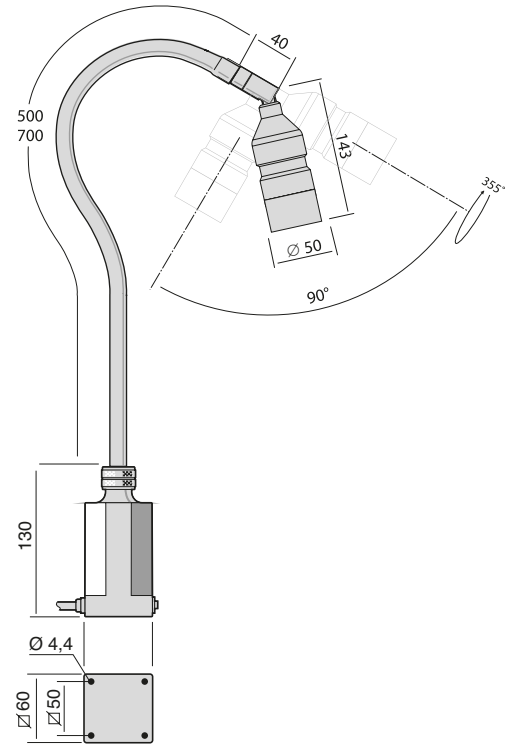
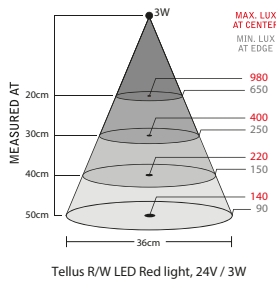
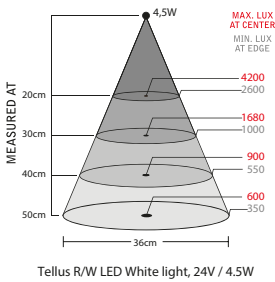

Arm	Connection	Version	Part.no
500mm	12-24V AC/DC	IP43	34500
500mm	12-24V AC/DC	IP20, Joint	34510
700mm	12-24V AC/DC	IP43	34520
700mm	12-24V AC/DC	IP20, Joint	34530

#### PSU (100-240V~)



Plug-in Adaptor for Europe 230V  
33901

#### Mounting Accessories



Magnetic base  
14000

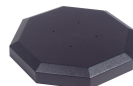

Table base  
14015



C-Clamp  
14020



Wall mount  
14030

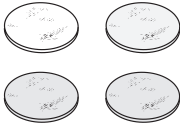
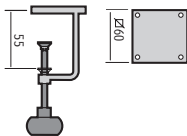
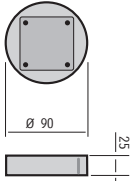
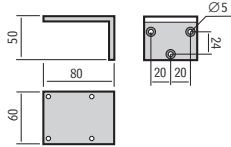
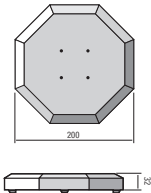
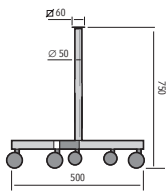
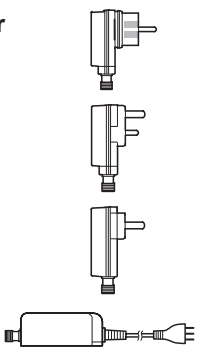

Accessory	Suitable for	Info	Part. no.
<b>Lens/Glass</b> 	Tellus R/W	Clear	15402
	Tellus R/W	Frosted (std)	15112
	Tellus R/W	Red	15114
	Tellus R/W	Green	15110
<b>C-clamp</b> 	All with std. base M4 x 20 (4x) included	Max. 42mm	14020
<b>Magnetic base</b> 	Tellus/Lumius/Pluto/CL-LED/LS M4 x 20 (4x) included	∅ 90mm	14000
<b>Wallmount</b> 	All with std. base M4 x 20 (4x) included	50 x 80mm	14030
<b>Desktop base</b> 	All with std. base 4.0 x 25 (4x) included	∅ 200mm	14015
<b>Trolley base</b> 	All with std. base M4 x 20 (4x) included	Height 750mm	14024
<b>AC/DC-Adapter</b> 	Pluto/Tellus/Solus6/Solus9/ Lumius/LS/CL-LED/Luxor (Euro)	100-240V/24VDC Max 15VA, IP44	33901
	Pluto/Tellus/Solus6/Solus9/Lumius/ LS (UK)	100-240V/12VDC Max 12VA, IP44	33902
	Pluto/Tellus/Solus6/Solus9/Lumius/ LS (US)	100-240V/12VDC Max 12VA, IP44	33906
	Pluto/Tellus/Solus6/Solus9/Lumius/ LS/CL-LED/Luxor (CH)	100-240V/24VDC Max 15VA, IP44	33907